

Revision History			
Revision	Description	Drawn By	Date
A	Released	PW	31/7/17

Routing Preperation

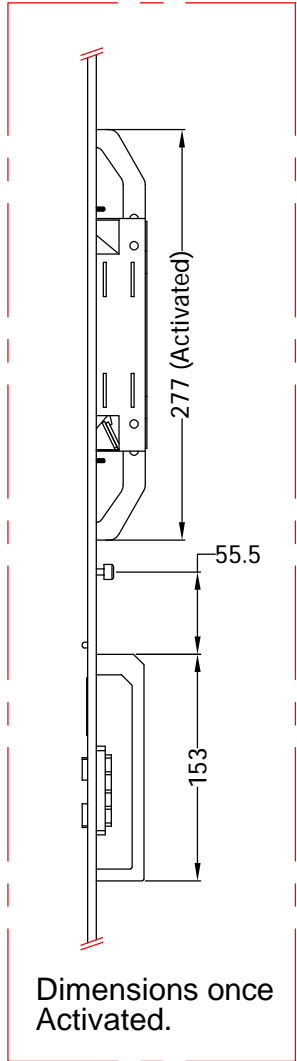

Dimensions once Activated.

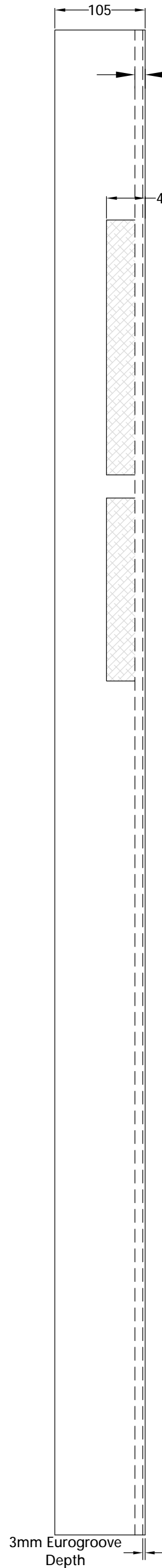
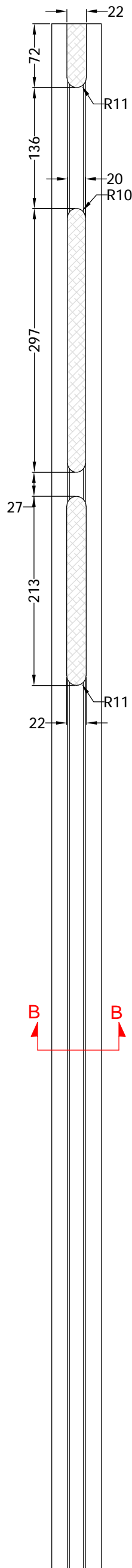
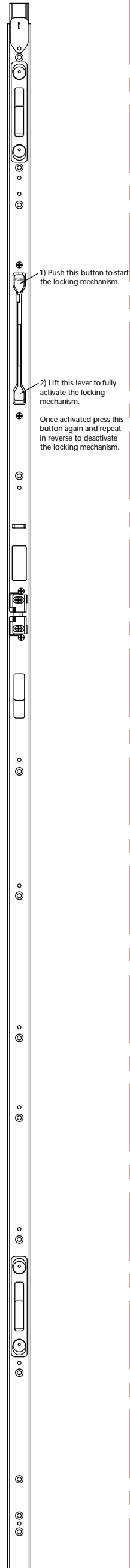
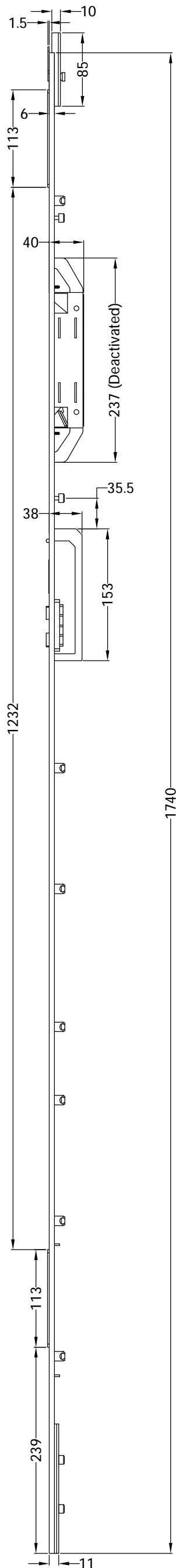

12mm
Depth

Handing Diagrams

Single Doors

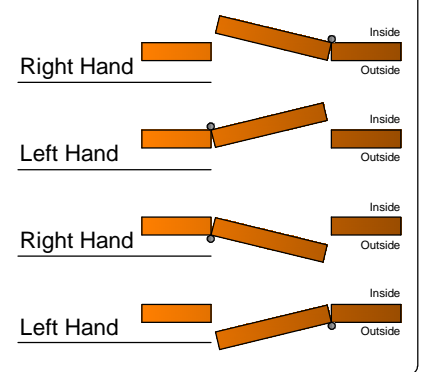

Double Doors

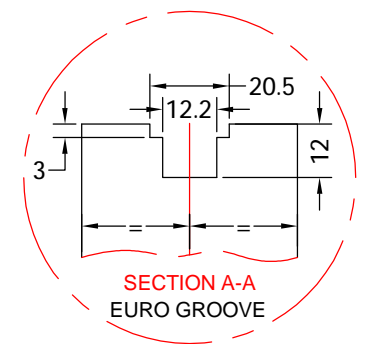
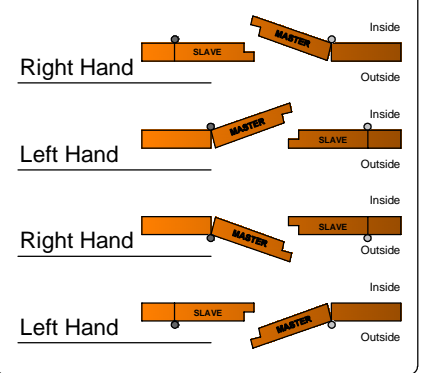

SECTION B-B

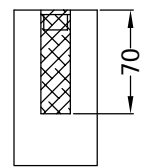



Global House, Bojca Industrial Estate, Trethowel, St Austell, PL25 5RJ
 telephone | 01726 871724 - fax | 01726 871731
 email | sales@coastal-group.com - web | www.coastal-group.com

Drawing Reference:
Coastal Group
 Drawing Title:
ML30S
Solo Double Door Slave Door Lock
 Product Range:
SIZE 1 - 1740mm
 Additional Info: 26mm Faceplate
 Left Hand Shown, Right Hand Opposite

Date Drawn: 01/08/2017
 Drawn By: Phil Walklett
 Part Number: ML30-1
 File Name: CG-ML30-1.dwg
 Revision: A
 Drawing Scale: NONE
 Sheet Number: 1 of 1

THIRD ANGLE PROJECTION

This drawing and specification are the property of Coastal Group, they are issued in strict confidence and shall not be reproduced, copied or used without written permission.