

Revision History			
Revision	Description	Drawn By	Date
A	Release	PW	16/11/17

Right Hand

Left Hand

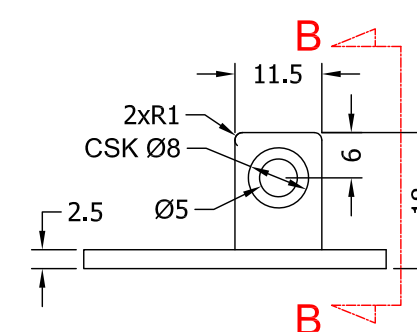
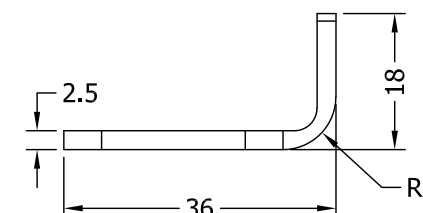
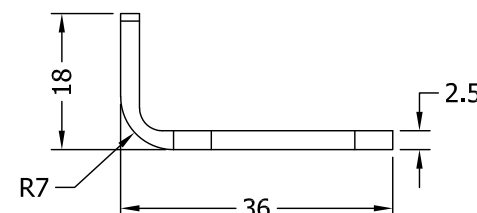
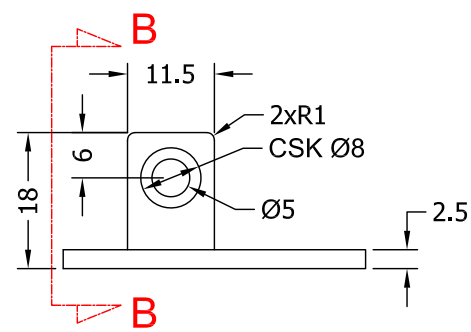
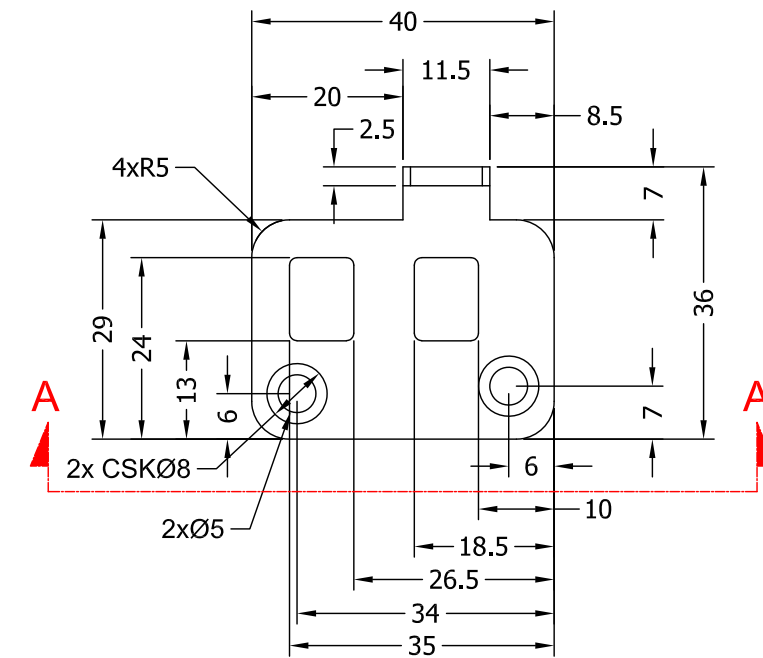
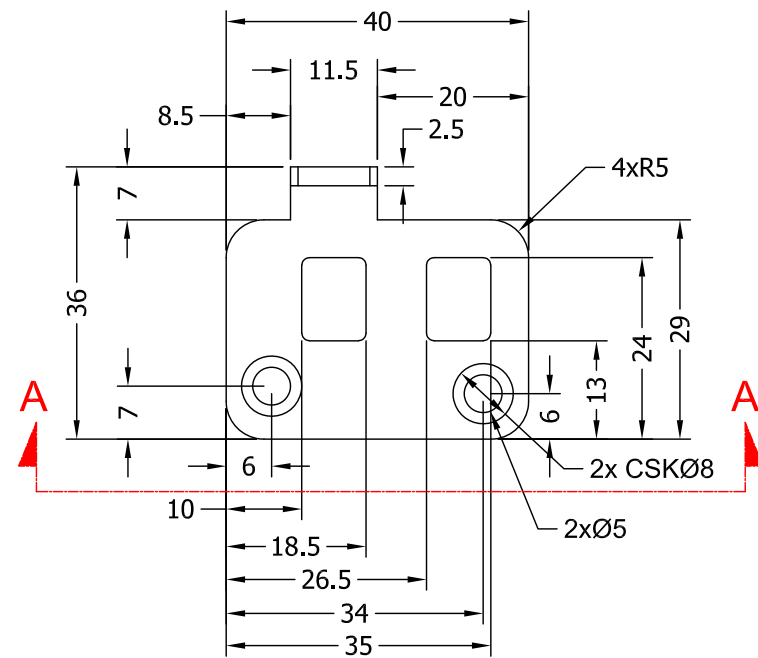

Section A-A

Section B-B

Section B-B

Section A-A

Right Hand Isometric View

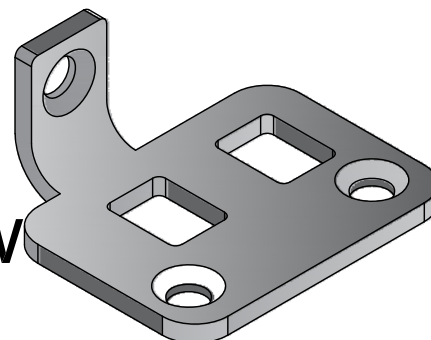

COASTAL GROUP
improving & upgrading the style, performance & longevity of external doors & windows globally

Global House, Bojes Industrial Estate, Trethowel, St Austell, PL25 5RJ
 Telephone | 01726 871725 - Fax | 01726 871731
 Email | sales@coastal-group.com - Web | www.coastal-group.com

Drawing Reference:
Coastal Group

Drawing Title:
Tritus Flush Window Bottom Night Vent Keep

Product Range:
Tritus Flush

Additional Info: **Used for Part Q Test**

Date Drawn: 16/11/2017
 Drawn By: Phil Walklett
 Part Number: FCK950-SV
 File Name: CG-FCK950-SV.dwg
 Revision: A
 Drawing Scale: 1:1@A3
 Sheet Number: 1 of 1

THIRD ANGLE PROJECTION
 This drawing and specification are the property of Coastal Group, they are issued in strict confidence and shall not be reproduced, copied or used without written permission.