

Right Hand Shown, Left Hand Opposite.

REVISION HISTORY

Revision	Description	Drawn	Date
A	Release	PW	03/09/18

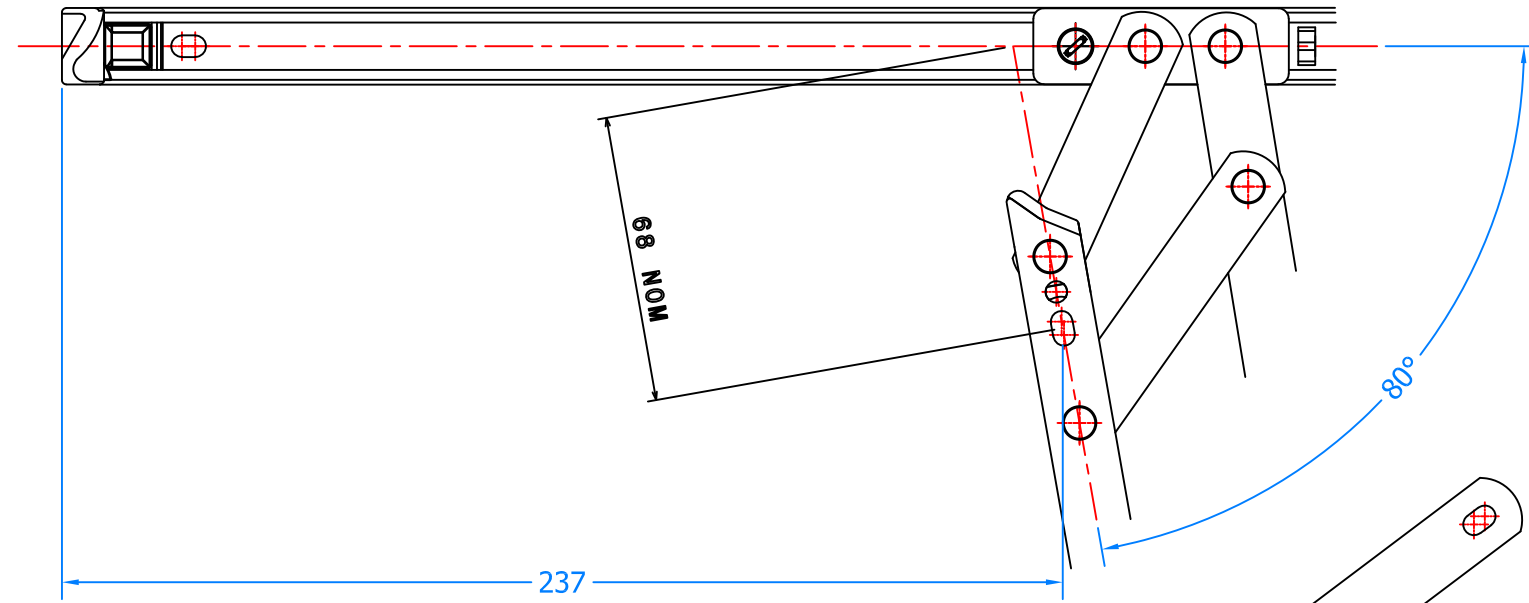

Hinge Project Out Dimension

Only operate the hinge in the direction shown by this arrow. Hinges are sold in pairs which are handed.

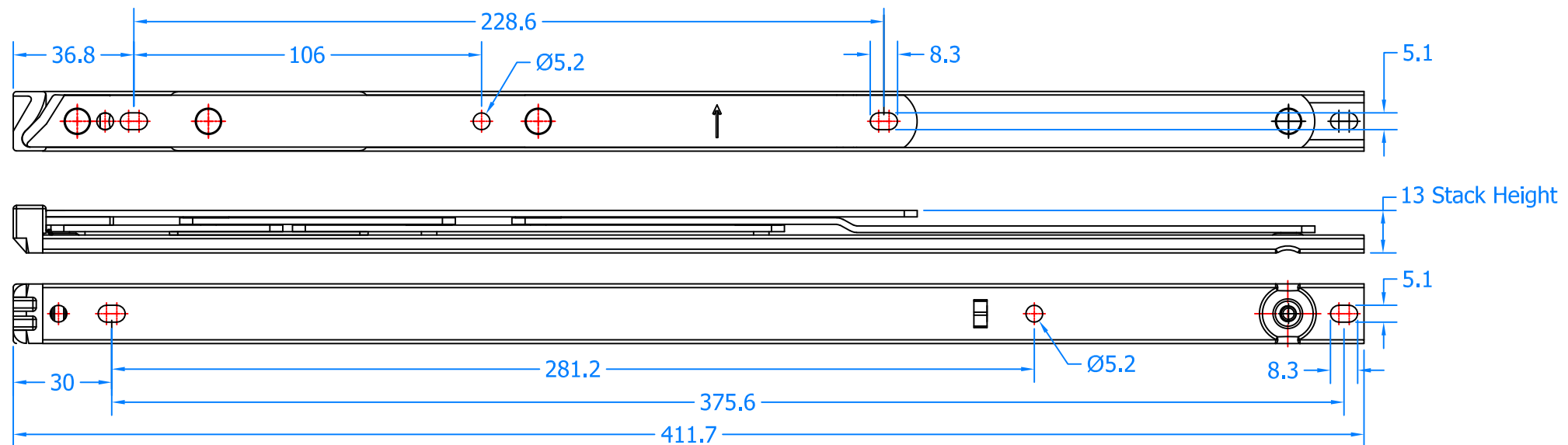
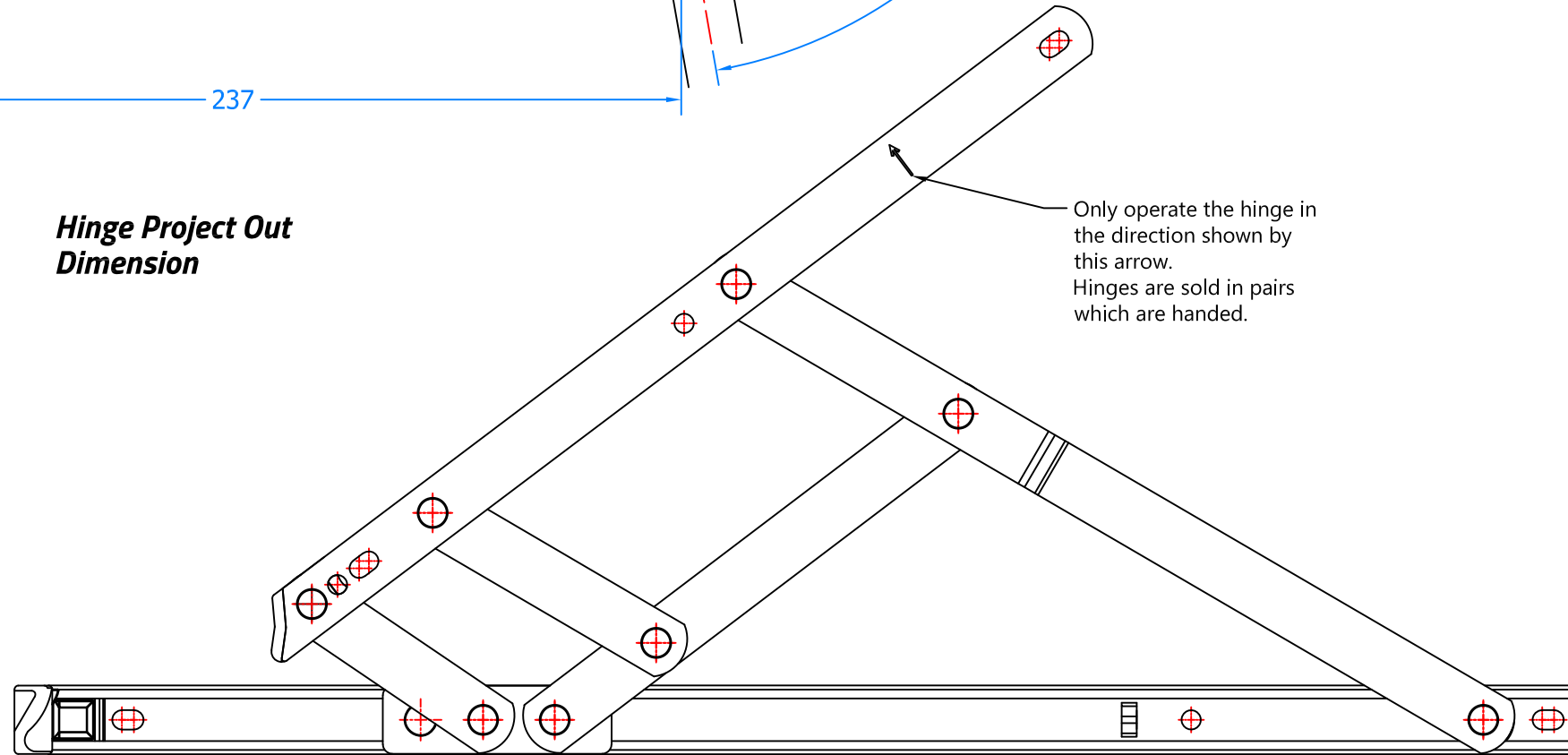

Innovating & Upgrading the Style, Performance & Longevity of External Doors & Windows Globally.

Coastal Specialist Ironmongery Ltd.

Global House, Bojea Industrial Estate, Trethowel, St Austell, PL25 5RJ
 t | 01726 871725 - f | 01726 871731 - e | sales@coastal-group.com
 w | www.coastal-group.com

Drawing Title:
DT16-TV-SS
16" Top Hung Defender Standard

Product Range:
Friction Hinges

Additional Info: **TOP HUNG**

Date Drawn: 03/09/2018

Drawn By: Phil Walklett

Part Number: **DT16-TV-SS**

File Name: CG-DT16-TV-SS.dwg

Revision: **A**

Drawing Scale: Not to Scale

Sheet Number: 1 of 1

THIRD ANGLE PROJECTION

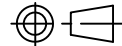

This drawing and specification are the property of Coastal, they are issued in strict confidence and shall not be reproduced, copied or used without written permission.