

This drawing and specification are the property of the Coastal Group. They are issued in strict confidence and shall not be reproduced, copied or used without written permission.

Revision History			
Revision	Description	Drawn By	Date
A	Released	PW	8/8/17

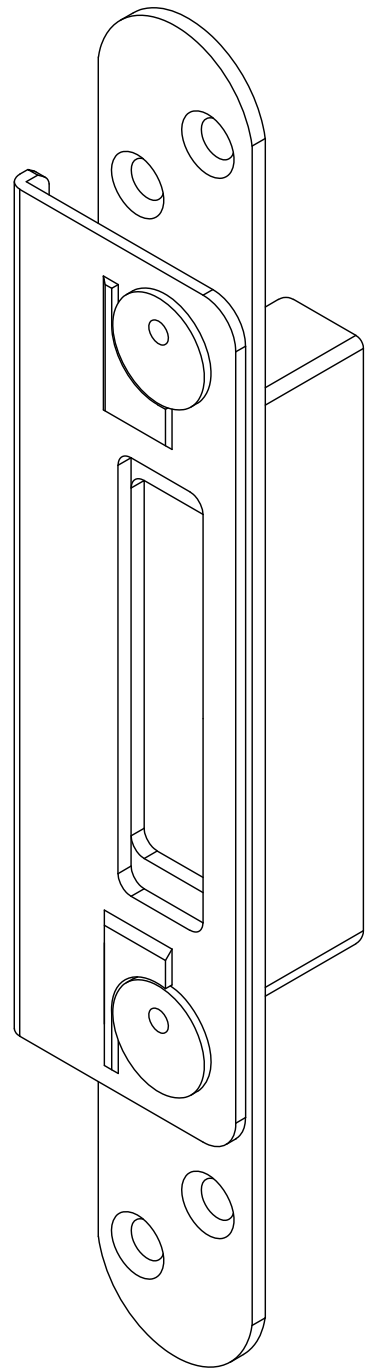

Isometric View

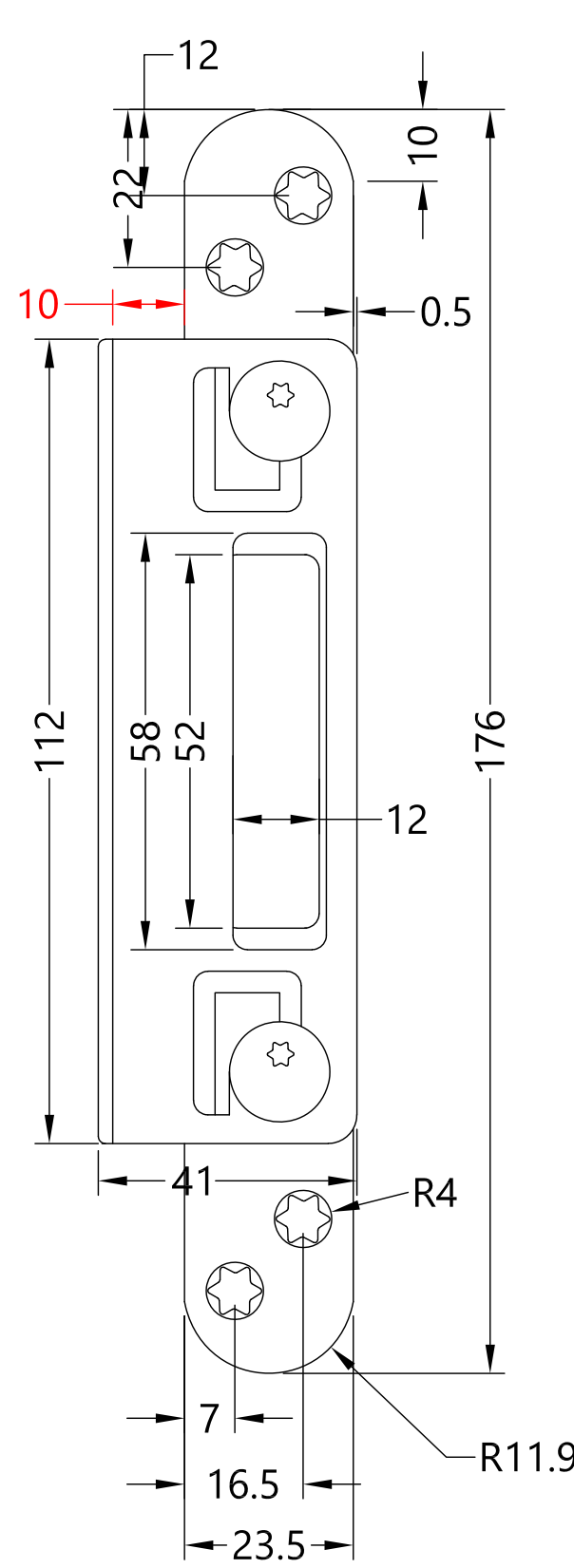

Adjustment TOP

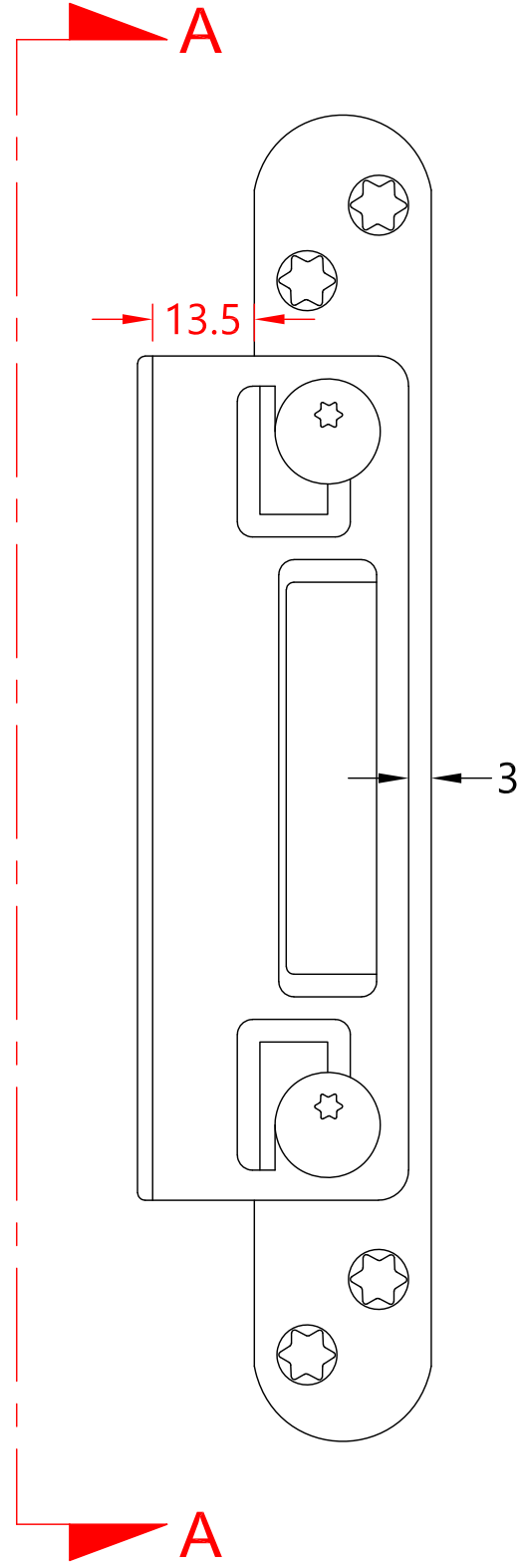

Adjustment BOTTOM

+/- 3.5mm Adjustment

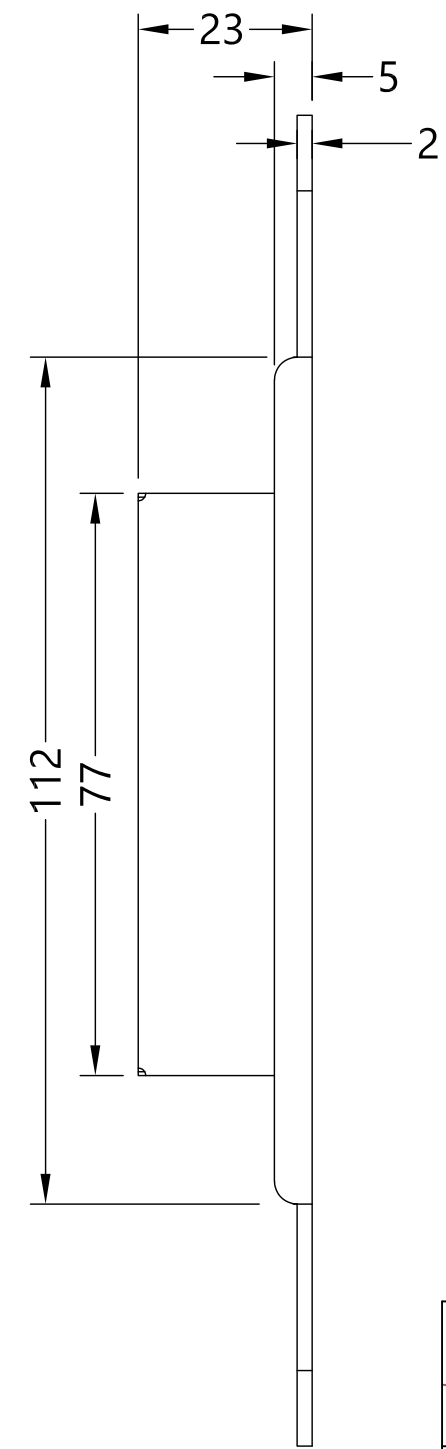

Section A-A

Global House, Bojca Industrial Estate, Trethowel, St Austell, PL25 5RJ
 telephone | 01726 871724 - fax | 01726 871731
 email | sales@coastal-group.com - web | www.coastal-group.com

Drawing Reference:
Coastal Group
 Drawing Title:
MK7-TAB-22-SV
Single Keep with 22mm Centre
 Product Range:
Adjustable Hook/Deadbolt Keeps
 Additional Info: **With Return for Auto-Locks**
Universal Handing
 Date Drawn: 08/08/2017
 Drawn By: Phil Walklett
 Part Number: **MK7-TAB-22-SV**
 File Name: **CG-MK7-TAB-22-SV.dwg**
 Revision: **A**
 Drawing Scale: 1:1@A3
 Sheet Number: 1 of 1

THIRD ANGLE PROJECTION

This drawing and specification are the property of Coastal Group, they are issued in strict confidence and shall not be reproduced, copied or used without written permission.