

Guru Locking



Features

- **Solid die cast Zinc construction**
Heavyweight handle with sturdy feel
- **Classic design with a contemporary twist**
Create an elegant and stylish window
- **Heavy duty sprung latching wedge**
Positive click on closing
- **Patented cover caps with colour coordinated finish**
Perfectly matching hardware, even down to the smallest details
- **Key clicks into place when inserted**
Won't fall out of the lock, even when pivoting the lever
- **Slimline and standard keeps available**
Compatible with various frame section configurations



Hardex
Chrome



Hardex
Satin

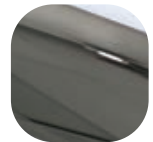

Hardex
Bronze

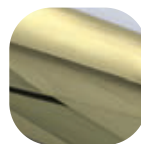

Hardex
Gold

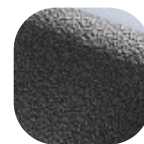

Antique
Black



White

10
YEAR

Mechanical
Guarantee

t

Timber

Guru Locking

Ordering Details

Product

Guru Locking

Finish	Part No.	
Handles	Right Hand	Left Hand
Hardex Chrome	0H001	0H101
Hardex Satin	0H002	0H102
Hardex Bronze	0H003	0H103
Hardex Gold	0H005	0H105
Antique Black	0H006	0H106
White	0H000	0H100
Keeps	Standard	Slimline
Hardex Chrome	0H401	0H501
Hardex Satin	0H402	0H502
Hardex Bronze	0H403	0H503
Hardex Gold	0H405	0H505
Antique Black	0H406	0H506
White	0H400	0H500

For additional part numbers please contact our sales office.

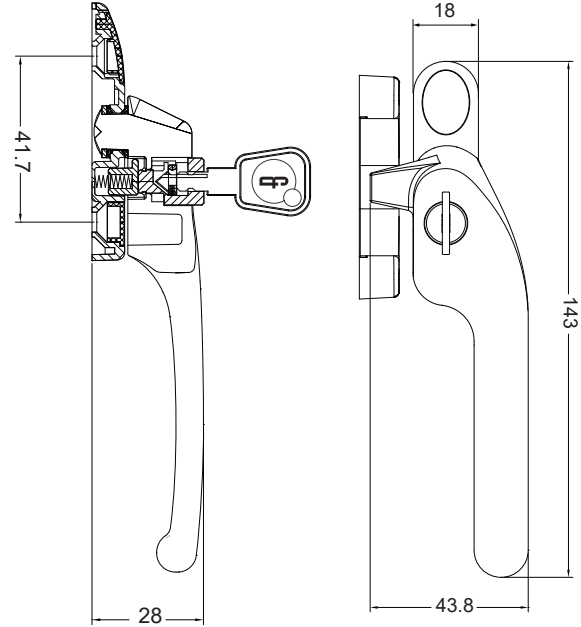

Technical Information

Corrosion resistance

Meets the requirements of BS EN 1670:2007 Grade 5 (480 hours)

Operation

Endurance tested in excess of 50,000 cycles

Performance

Tested to meet the requirements of PAS 24 as part of a compliant window

Material Specification

Handle Grip and Backplate:	High quality Zinc for all finishes
Coatings:	Hardex Chrome, Satin, Bronze, Gold, Antique Black and White

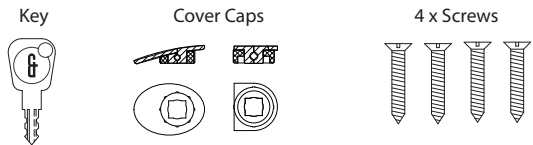

Standard Keep

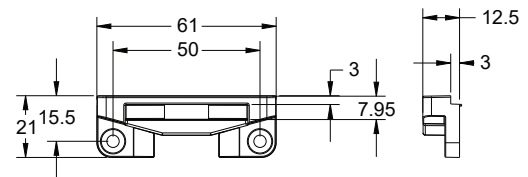

Slimline Keep

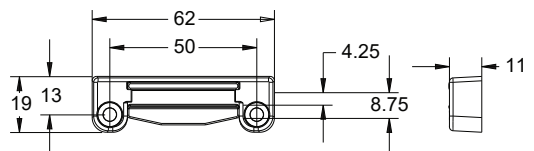

Maintenance

For continued protection of the quality finish and appearance, routine cleaning of all our external hardware. Moving parts should also be lightly lubricated at least twice a year. This procedure is particularly essential if products are used within a 25-mile radius of coastal areas or close proximity to building sites or large industrial areas, where more frequent cleaning may be required to prevent the accumulation of corrosive contaminants.

Packaging

Handles

Individually bagged with screws and care instructions.