

While every attempt has been made to ensure the accuracy and completeness of the information in this document some typographical or technical errors may exist. The Coastal Group cannot accept responsibility for customers' losses resulting from the use of this document. Please also note that this drawing / design is subject to change without prior notice in accordance with policy of continual product development. This drawing / design contains proprietary information that is protected by copyright and is property of the Coastal Group. The Coastal Group is at the leading edge in joinery hardware, customer care and quality are at the core of everything we do, you can be confident that a call to Blu will be the only call you need for all your joinery hardware needs.

## INTERNAL LEVER HANDLE

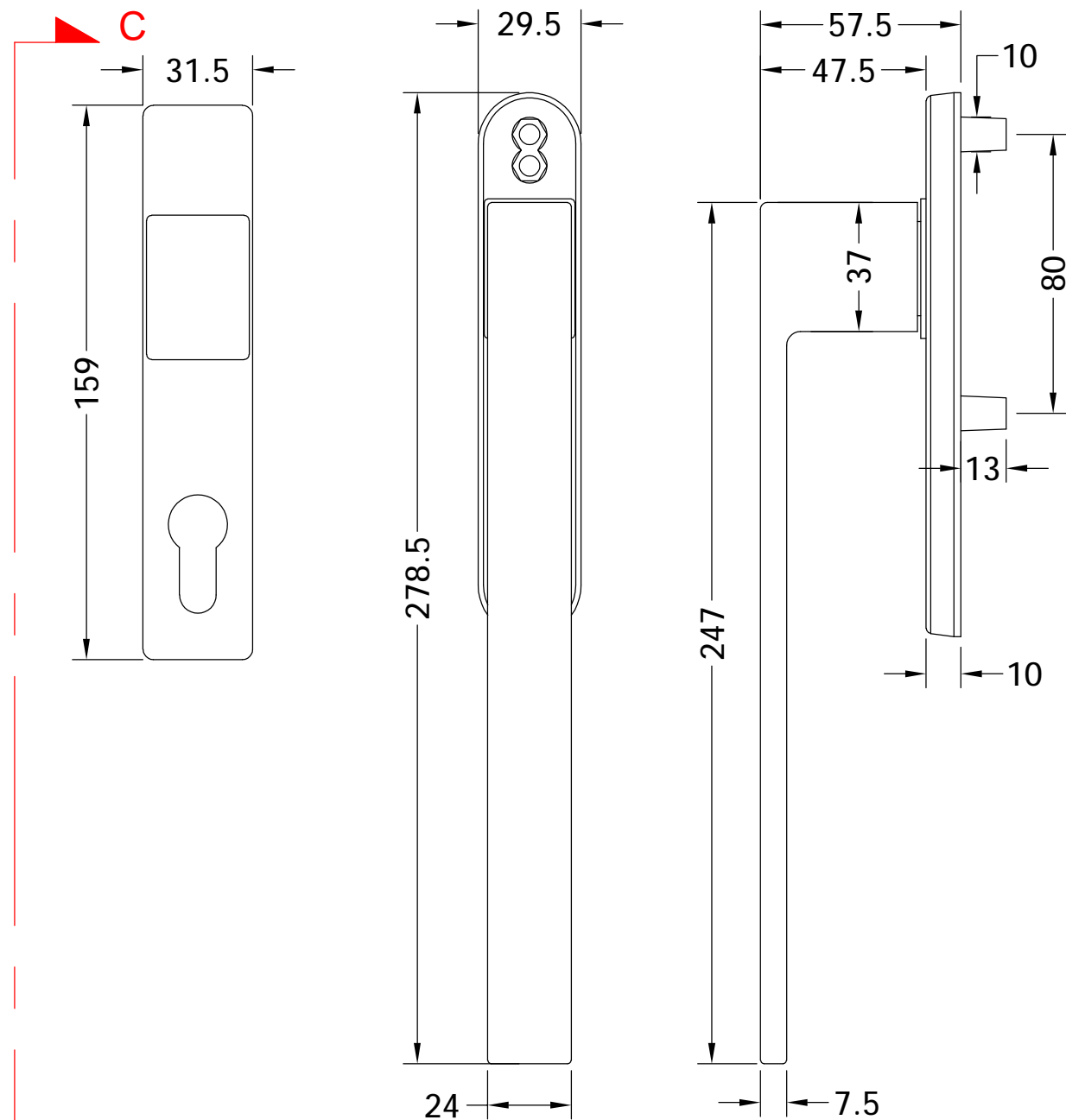

Section C-C

## EXTERNAL FLUSH PULL

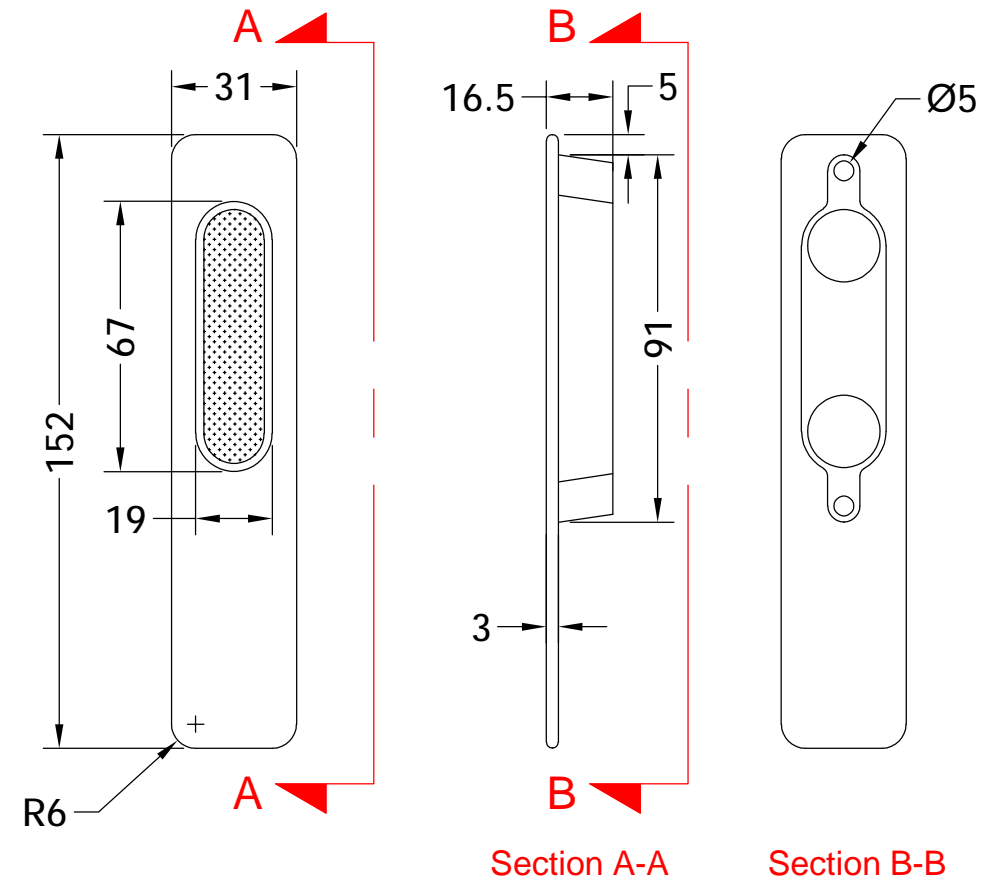

Section A-A

Section B-B

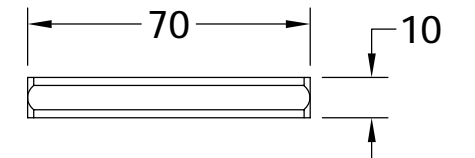

1 x 70mm Spindle

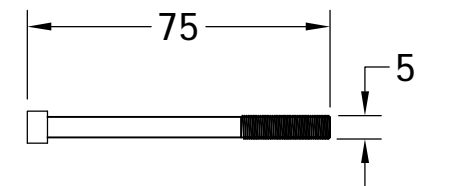

2 x 75mm Machine Screws to suit 70mm thick doors

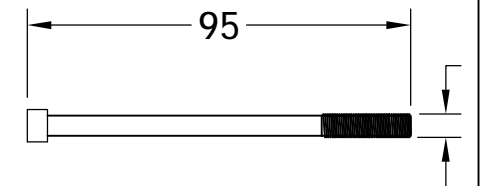

2 x 95mm Machine Screws to suit 90mm thick doors

## Assembled View

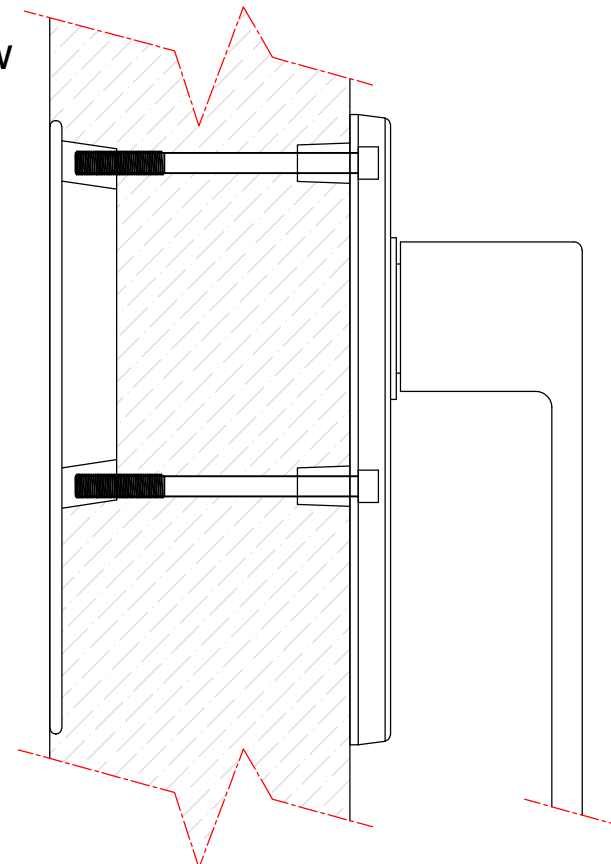

### WHAT'S INCLUDED IN THE BOX

QTY	DESCRIPTION
1	INTERNAL LEVER HANDLE
1	COVERPLATE
1	EXTERNAL FLUSH PULL
2	95mm MACHINE SCREWS
2	70mm MACHINE SCREWS
1	70mm SPINDLE

**COASTAL GROUP**  
 Global House, Bojea Industrial Estate, Trethowel, St Austell, PL25 5RJ  
 telephone | 01726 871724 - fax | 01726 871731  
 email | sales@coastal-group.com - web | www.coastal-group.com

Drawing Reference:  
**Coastal Group**  
 Drawing Title:  
**Lift & Slide Square Lever/Flush Pull Universal - Non Handed**  
 Product Range:  
**LS124MD**  
 Additional Info:  
 Date Drawn: 18/07/2017  
 Drawn By: Phil Walklett  
 Part Number: LS124MD  
 File Name: CG-LS124MD.dwg  
 Revision: A  
 Drawing Scale: None  
 Sheet Number: 1 of 1

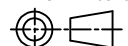
THIRD ANGLE PROJECTION  
  
 This drawing and specification are the property of Coastal Group, they are issued in strict confidence and shall not be reproduced, copied or used without written permission.