

REVISIONS			
Revision	Description	Drawn	Date
A	Release	PW	14/11/17

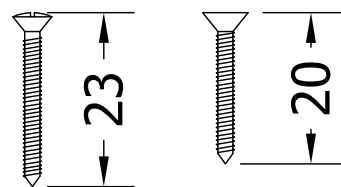
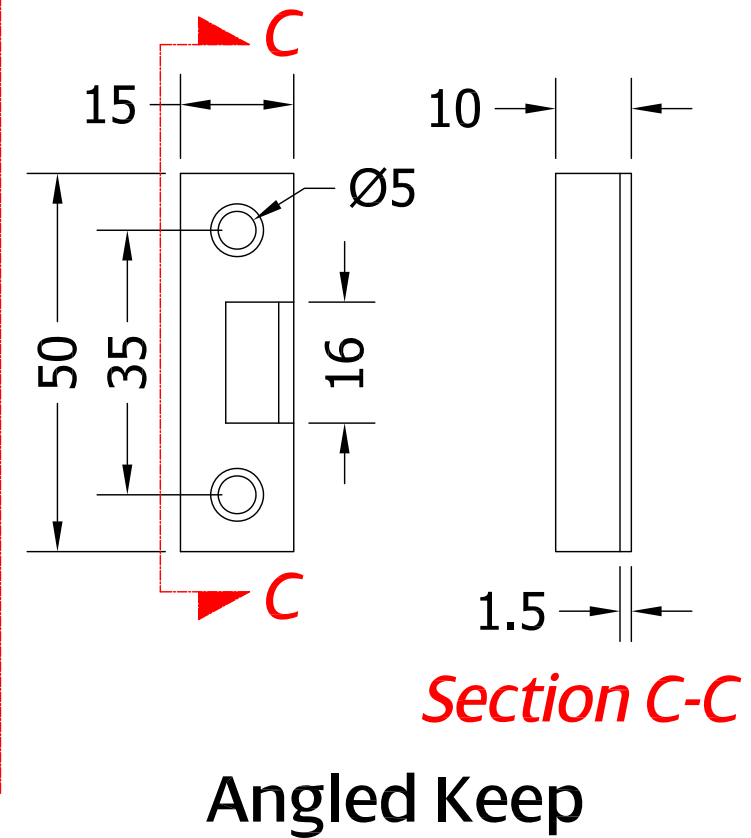
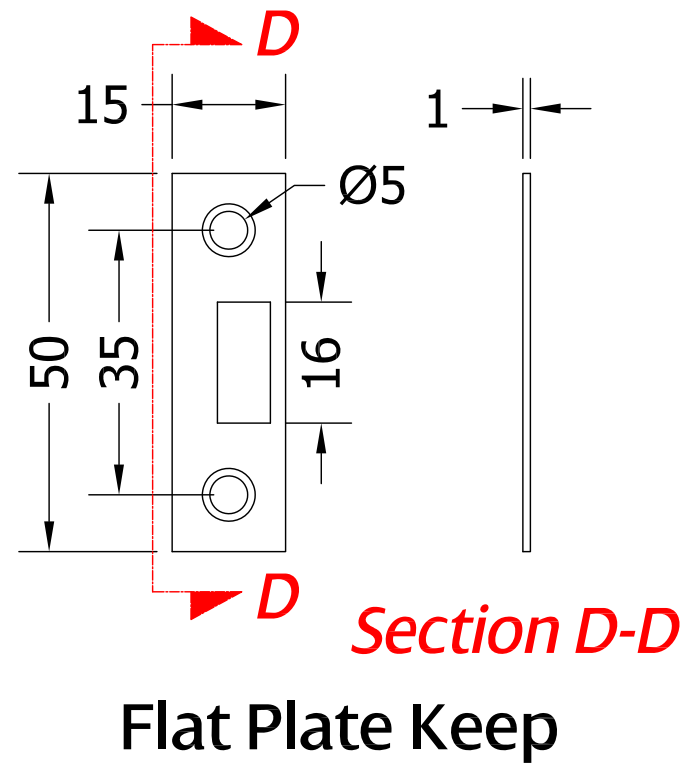
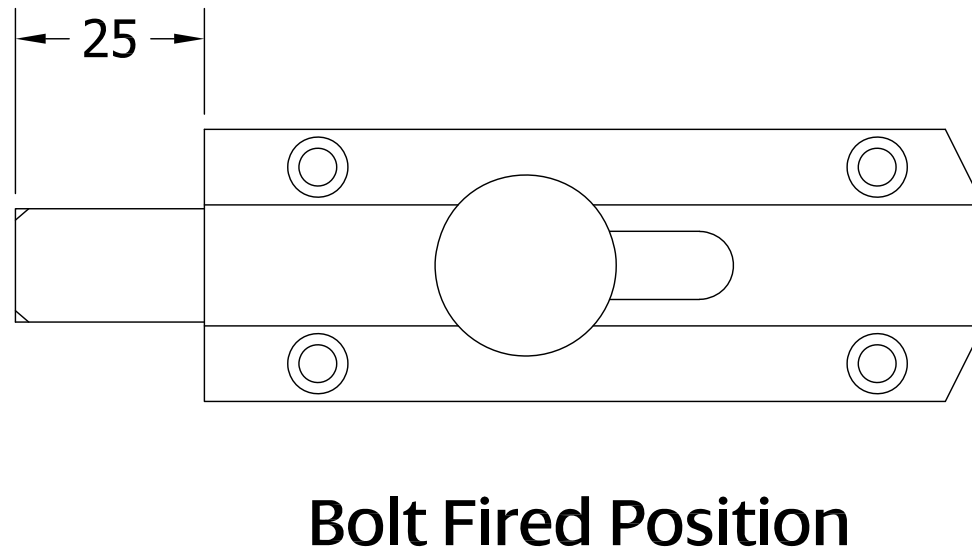
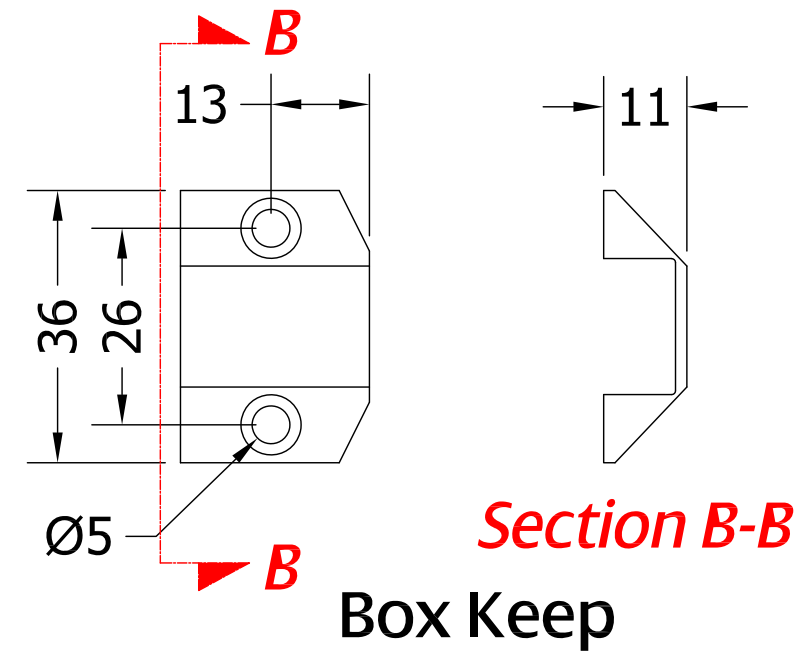
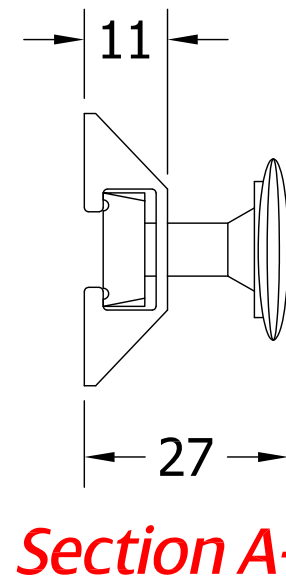
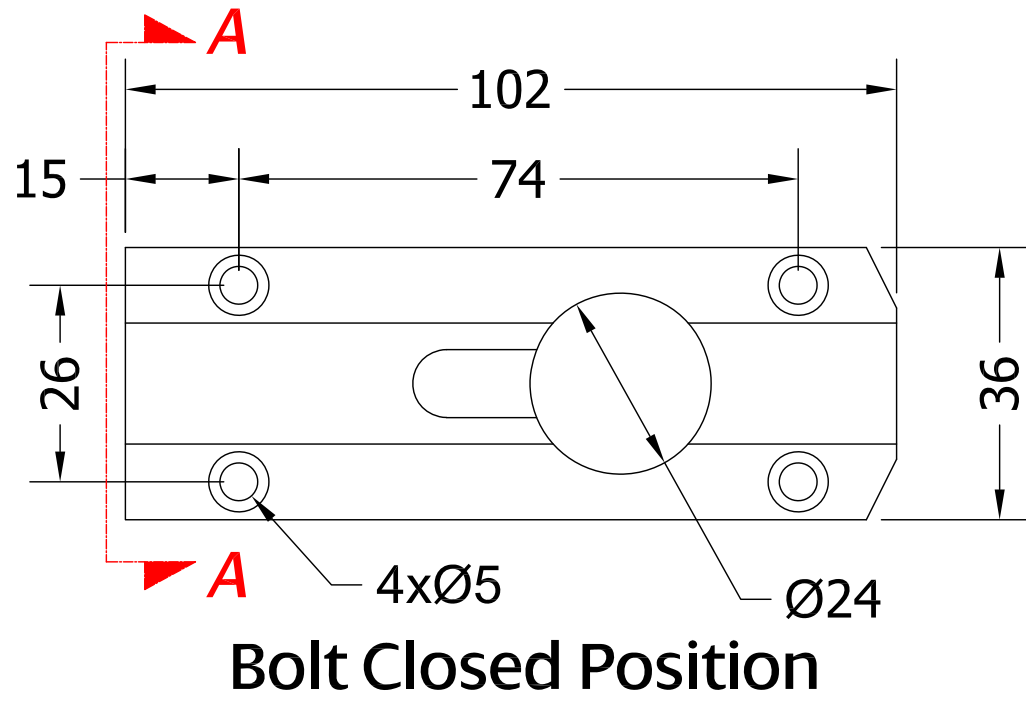

**COASTAL GROUP**  
Innovating & upgrading the style, performance & longevity of external doors & windows globally

Global House, Bojea Industrial Estate, Trethowel, St Austell, PL25 5RJ  
 Telephone | 01726 871725 - Fax | 01726 871731  
 Email | sales@coastal-group.com - Web | www.coastal-group.com

Drawing Reference:  
**Coastal Group**  
 Drawing Title:  
**AQ81**  
**Surface Slide Door Bolts**  
 Product Range:  
**Door Bolts**  
 Additional Info:

Date Drawn:	14/11/2017
Drawn By:	Phil Walklett
Part Number:	AQ81
File Name:	CG-AQ81.dwg
Revision:	A
Drawing Scale:	1:1@A3
Sheet Number:	1 of 1

THIRD ANGLE PROJECTION This drawing and specification are the property of Coastal Group, they are issued in strict confidence and shall not be reproduced, copied or used without written permission.