

Drawing Revision History		
Revision	Description /Change	Date
A	Release	12/11/2021
B	Screw Lengths Revised	27/6/2023

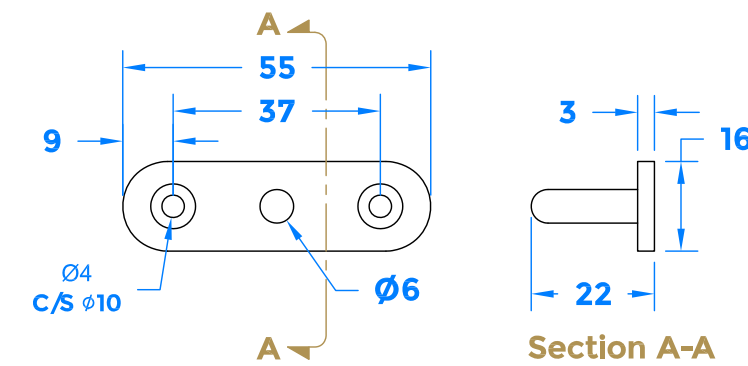

### Casement Stay Fasteners

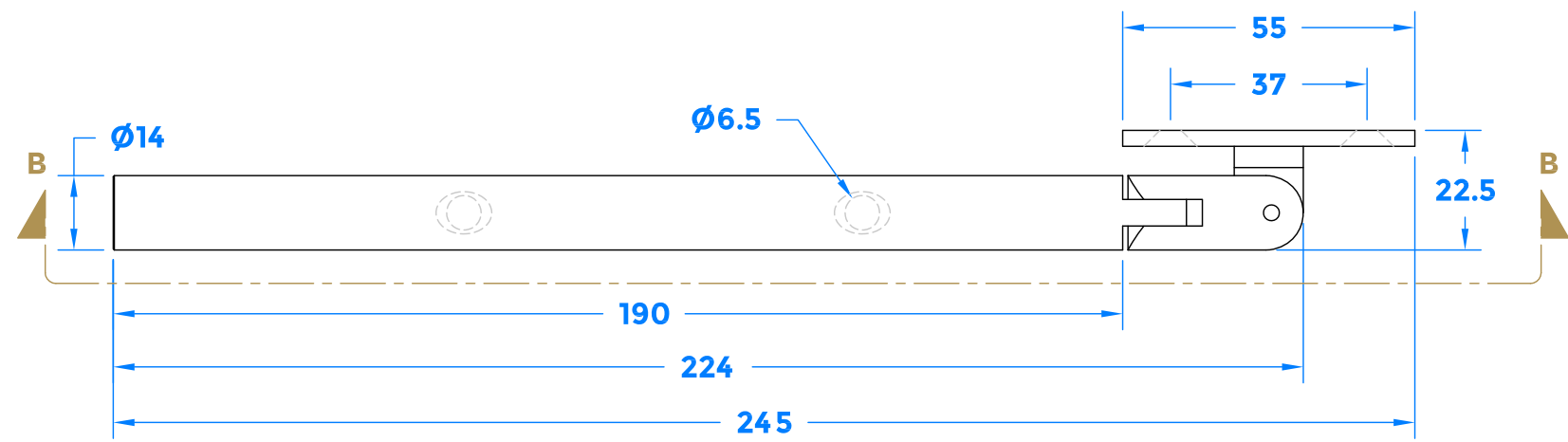
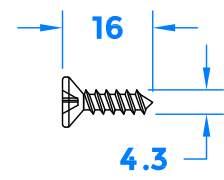
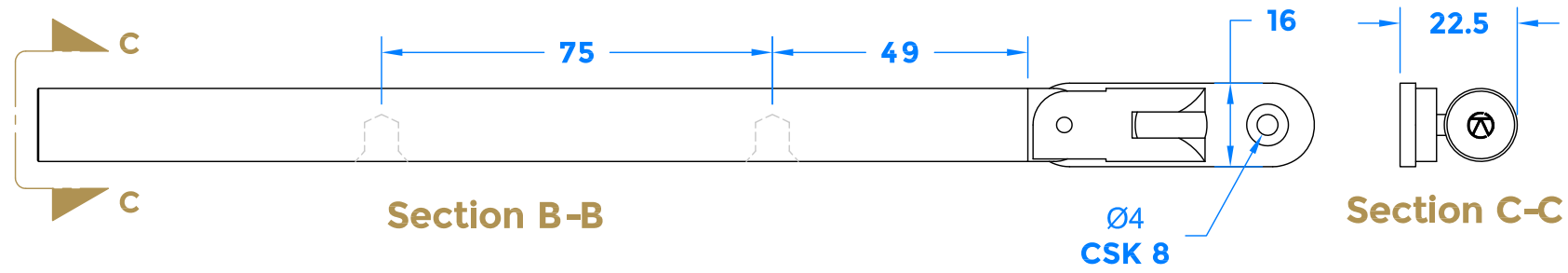

### Wood Screws

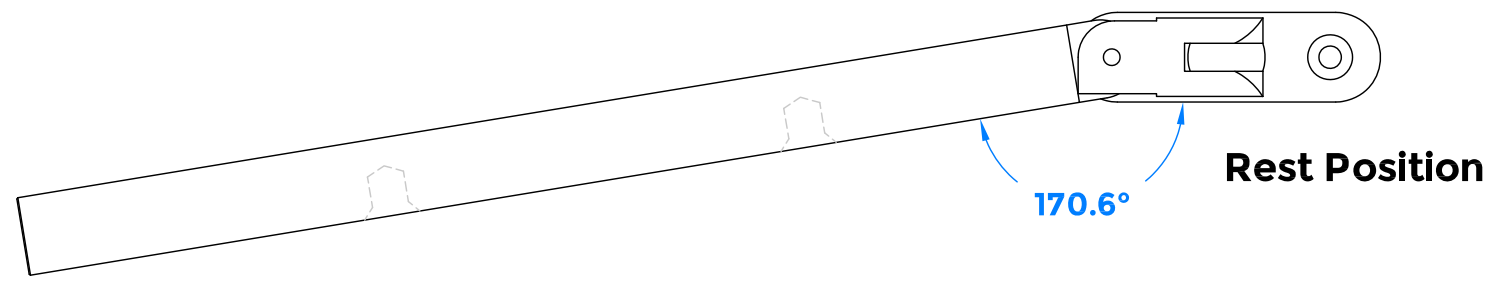

### Assembled View

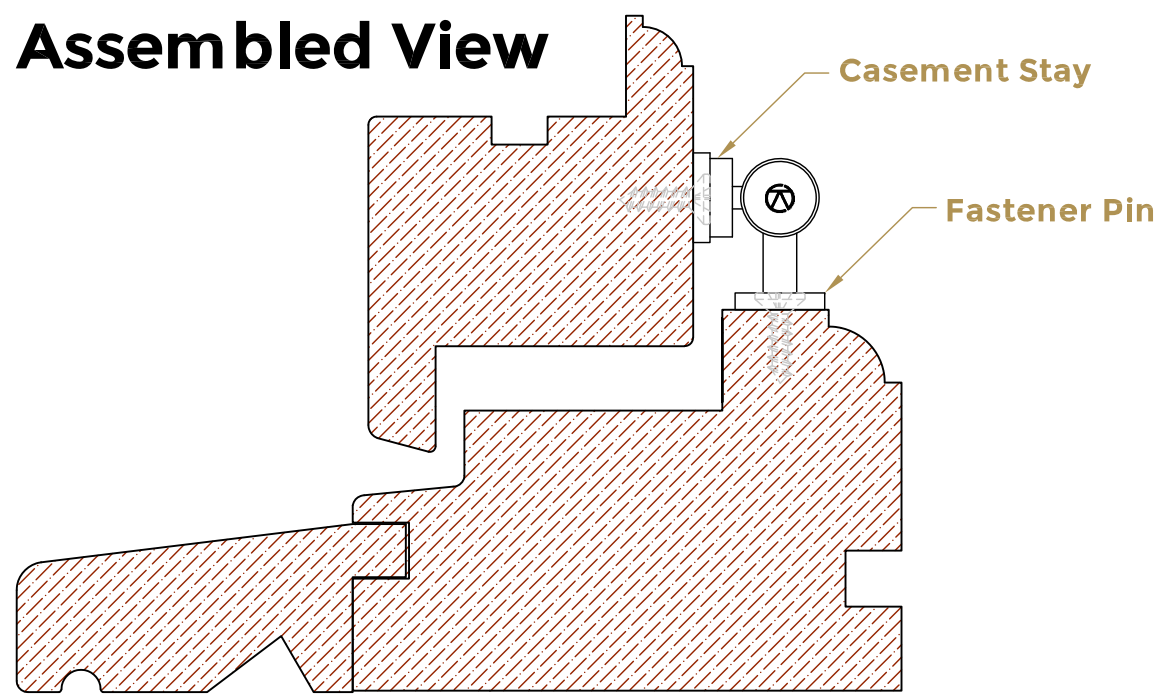

[coastal-group.com](http://coastal-group.com)  
*Shaping the future.*

**COASTAL**

Part Number /Drawing Title:  
**SST93**  
**BLU Casement Window Stay**

Product Range:  
**Casement Stays & Fasteners**

Material: 316 Stainless Steel

Additional Info:

Date Drawn: 27/06/2023  
 Drawn By: Phillip Walklett

Part Number: SST93  
 File Name: SST93.dwg

Revision: B

Drawing Scale: Not to Scale

Sheet Number: 1 of 1

THIRD ANGLE PROJECTION

This drawing and specification are the property of Coastal Specialist Ironmongery Ltd, they are issued in strict confidence and shall not be reproduced, copied or used without written permission.  
 EAOE - All dimensions are specified in mm.