

*Key Operated Multipoint Lock for  
Heritage Doors*

ML130R Heritage Door Lock

T 01726 871 025 E [sales@coastal-group.com](mailto:sales@coastal-group.com) W [coastal-group.com](http://coastal-group.com)  
© Coastal Specialist Ironmongery Ltd



**COASTAL**

*Shaping the future.*

## HERITAGE MULTIPOINT LOCK – KEY OPERATED

---

### TECHNICAL INFORMATION:

- 92mm Euro Lock Centre
- 45 or 55mm Backset options
- Universal Lock Handing  
(Latch Release)



### FEATURES:

- Euro cylinder and gearbox located at shoulder height (approx. 1350mm) to create a Heritage look with modern, secure multipoint locking system
- 5-point locking system with twin tapered deadbolts
- Twin tapered deadbolts provide low operating force, perfect sealing compression and increased weather protection
- Up to 50% greater fitting tolerances than hooks
- Ultra smooth key/thumbturn activated gearbox
- Daytime latch enables temporary release of locking system allowing easy re-entry e.g. when carrying shopping in from car



ML130 - Twin tapered bolts key operated. Turn key 720 degrees to unlock/lock.

## HERITAGE MULTIPOINT LOCK – KEY OPERATED

### DAYTIME LATCH FEATURE



#### Blue switch in 'down' position

- Daytime Latch activated - Door can be pushed and pulled to open and close without key
- Prevents door from blowing open
- Very convenient for example when bringing shopping in from car



- To deactivate Daytime Latch simply push blue switch up



#### Blue switch in 'up' position

- Daytime Latch deactivated
- Duo Hook Locks fired by magnet once door is closed
- Door securely locked once more
- Key required to unlock and open door

### Keep Handing (as viewed from outside)

Left Hand Lock

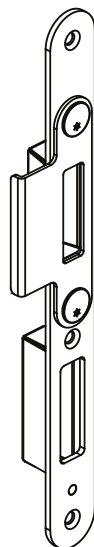

Right Hand Lock

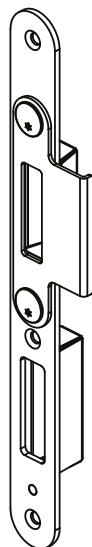

## KIT CODES

KIT PART NUMBER	HANDING	BACKSET	FACEPLATE	CENTRE	FINISH	UNITS
ML130R-KIT-45-28-LH	Left	45mm	20mm Radius	28mm	SV	Each
ML130R-KIT-45-28-RH	Right	45mm	20mm Radius	28mm	SV	Each
ML130R-KIT-55-28-LH	Left	55mm	20mm Radius	28mm	SV	Each
ML130R-KIT-55-28-RH	Right	55mm	20mm Radius	28mm	SV	Each

Kit includes 1 x ML130R multipoint lock, 1 x MK39 Centre keep, 1 x MK39-Day day switch and 2 x MK7-FLU keeps

## COMPONENT CODES

LOCK PART NUMBER	HANDING	BACKSET	FACEPLATE	FINISH	UNITS
ML130R-45-SV	Universal	45mm	20mm Radius End	SV	Each
ML130R-55-SV	Universal	55mm	20mm Radius End	SV	Each

## KEEP CODES

KEEP PART NUMBER	PRODUCT DESCRIPTION	HANDING	CENTRE	FINISH	UNITS
MK7-FLU-SV	Single keep	Universal		SV	Each
MK39-28-LH-SV	Dust pocket centre keep	Left	28mm	SV	Each
MK39-28-RH-SV	Dust pocket centre keep	Right	33mm	SV	Each
MK39-DAY-LH	Daylatch switch	Left		SV	Each
MK39-DAY-RH	Daylatch switch	Right		SV	Each

## FINISHES:



SV  
 Silver Passivated

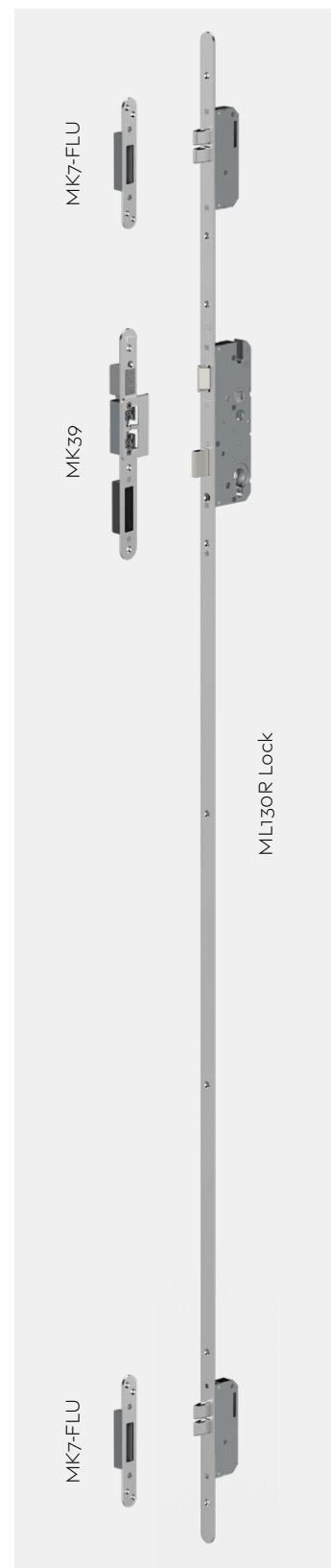

## HERITAGE MULTIPOINT LOCK – KEY OPERATED

What are faceplate widths?

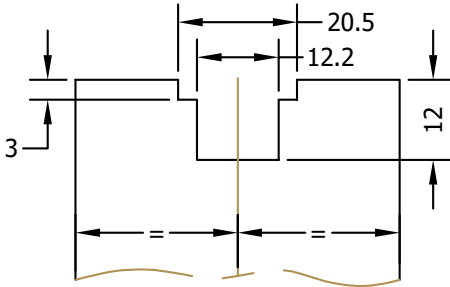

**SECTION A-A**  
**EURO GROOVE**

- Typical faceplate width is 20mm, this is measured across the face of the lock
- The diagram above shows typical routing detail

How to release the latch on a non-handled (universal) multipoint lock

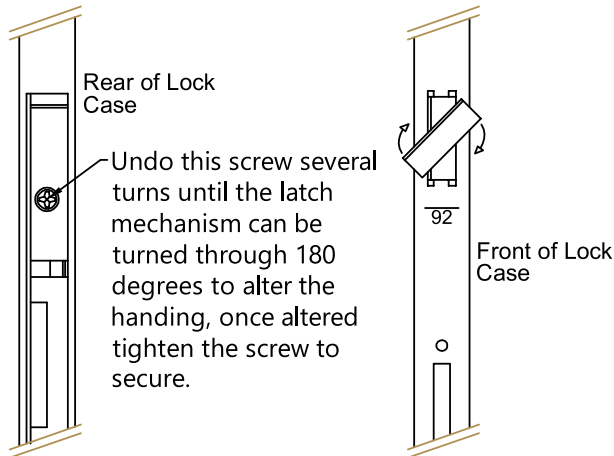

**Detail A**  
**Latch Release**

# HERITAGE MULTIPOINT LOCK – KEY OPERATED

MK7-FLU

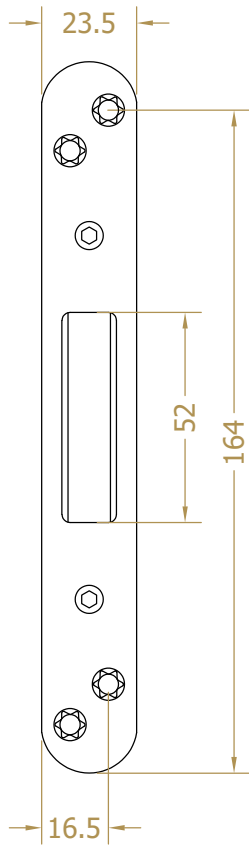

MK39 (RH shown)

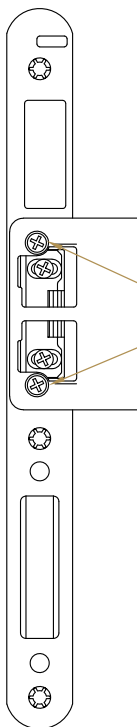
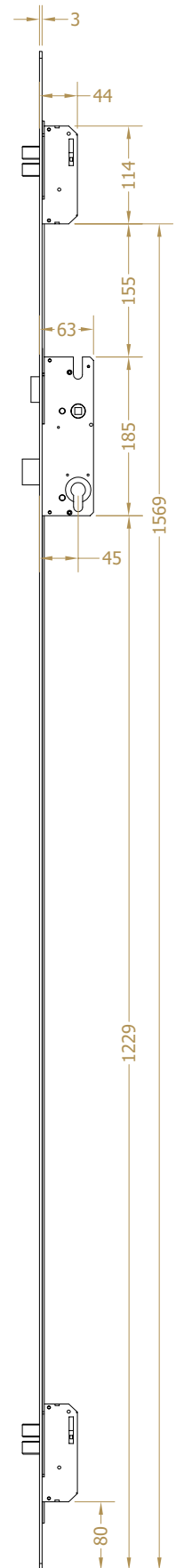
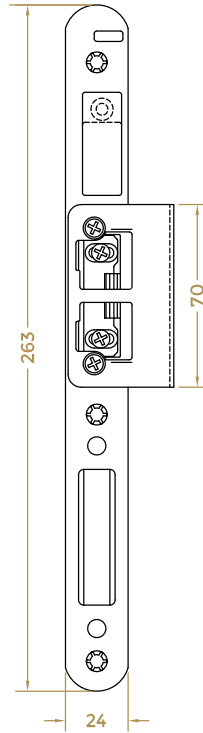

Remove the 2 screws to release the striker plate and the latch will detach from keep

