

Multipoint Lock for Single Doors

ML60R Single Door Radius End Lock

T 01726 871 025 E sales@coastal-group.com W coastal-group.com
© Coastal Specialist Ironmongery Ltd



COASTAL

Shaping the future.

SINGLE DOOR MULTIPOINT LOCK - RADIUS END

TECHNICAL INFORMATION:

- 92mm Euro Lock Centre
- 35, 45 or 55mm Backset options
- Universal Lock Handing (Latch Release)
- Size 2 lock



FEATURES:

- Winkhaus multipoint door lock for single doors
- Twin tapered deadbolts provide low operating force making door easy to lock whilst providing excellent weathersealing
- Key operated version
- High performance, strengthened centre gearbox
- Successfully tested on our Part Q Scheme
- Tested to PAS24 and Secured by Design Approved

Keep Handing (as viewed from outside)

Left Hand Lock

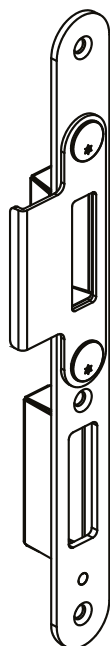

Right Hand Lock

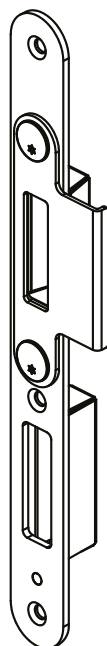

SINGLE DOOR MULTIPOINT LOCK - RADIUS END

KIT CODES

KIT PART NUMBER	HANDING	BACKSET	FACEPLATE	CENTRE	FINISH	UNITS
ML60R-KIT-45-28-2-LH	Left	45mm	20mm Square	28mm	SV	Each
ML60R-KIT-45-28-2-RH	Right	45mm	20mm Square	28mm	SV	Each
ML60R-KIT-45-33-2-LH	Left	45mm	20mm Square	33mm	SV	Each
ML60R-KIT-45-33-2-RH	Right	45mm	20mm Square	33mm	SV	Each

Kit includes 1 x ML60R multipoint lock, 1 x MK9 Centre keep and 2 x MK7-FLU keeps

COMPONENT CODES

LOCK PART NUMBER	HANDING	BACKSET	FACEPLATE	FINISH	UNITS
ML60R-35-2-SV	Universal	35mm	20mm Radius End	SV	Each
ML60R-45-2-SV	Universal	45mm	20mm Radius End	SV	Each
ML60R-55-2-SV	Universal	55mm	20mm Radius End	SV	Each

KEEP CODES

KEEP PART NUMBER	PRODUCT DESCRIPTION	HANDING	CENTRE	FINISH	UNITS
MK7-FLU-SV	Single keep	Universal		SV	Each
MK9-12-LH-SV	Centre keep	Left	12mm	SV	Each
MK9-12-RH-SV	Centre keep	Right	12mm	SV	Each
MK9-22-LH-SV	Centre keep	Left	22mm	SV	Each
MK9-22-RH-SV	Centre keep	Right	22mm	SV	Each
MK9-28-LH-SV	Centre keep	Left	28mm	SV	Each
MK9-28-RH-SV	Centre keep	Right	28mm	SV	Each
MK9-33-LH-SV	Centre keep	Left	33mm	SV	Each
MK9-33-RH-SV	Centre keep	Right	33mm	SV	Each
MK9-70-LH-SV	Centre keep	Left	70mm	SV	Each
MK9-70-RH-SV	Centre keep	Right	70mm	SV	Each
MK9-95-LH-SV	Centre keep	Left	95mm	SV	Each
MK9-95-RH-SV	Centre keep	Right	95mm	SV	Each
MK26-2-SV	Full length keep 2-part set	Universal	Adjustable	SV	Set
MK10-LH-SV	Centre keep	Left	33mm	SV	Each
MK10-RH-SV	Centre keep	Right	33mm	SV	Each
MK28-2-LH-SV	One piece radius end	Left	28mm	SV	Each
MK28-2-RH-SV	One piece radius end	Right	28mm	SV	Each
MK7-FTB-AAL	Flush single keep	Universal	Adjustable	SV	Each
MK9-FTB-28-AAL	Non-handed premium flush centre keep	Universal	28mm	SV	Each

FINISHES:

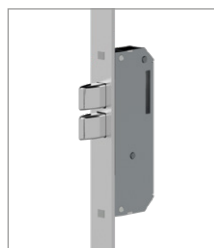

SV

Silver Passivated



What are faceplate widths?

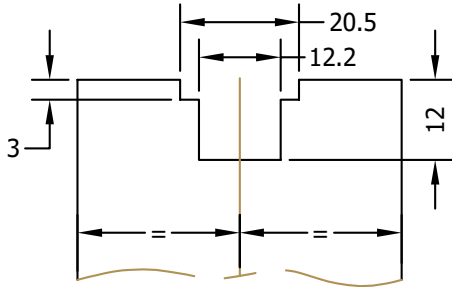

SECTION A-A
EURO GROOVE

- Typical faceplate width is 20mm, this is measured across the face of the lock
- The diagram above shows typical routing detail

How to release the latch on a non-handled (universal) multipoint lock

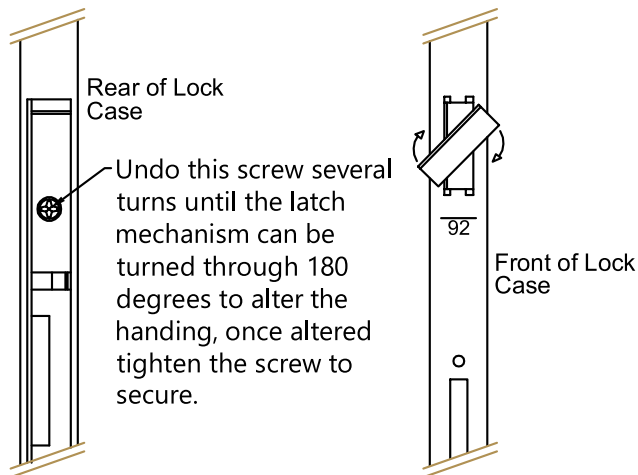

Detail A
Latch Release

SINGLE DOOR MULTIPOINT LOCK - RADIUS END

MK7-FTB

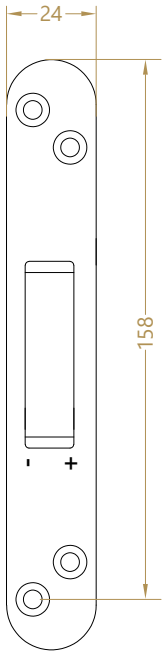

MK9-22

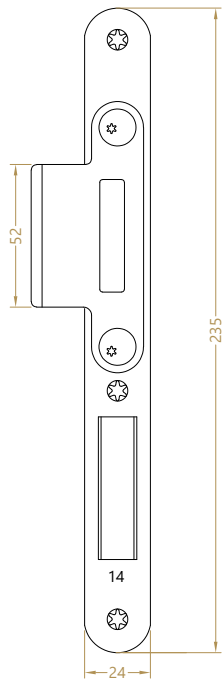

MK26-2

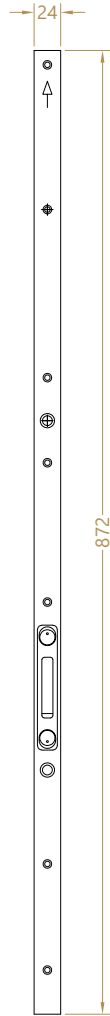

MK28-2

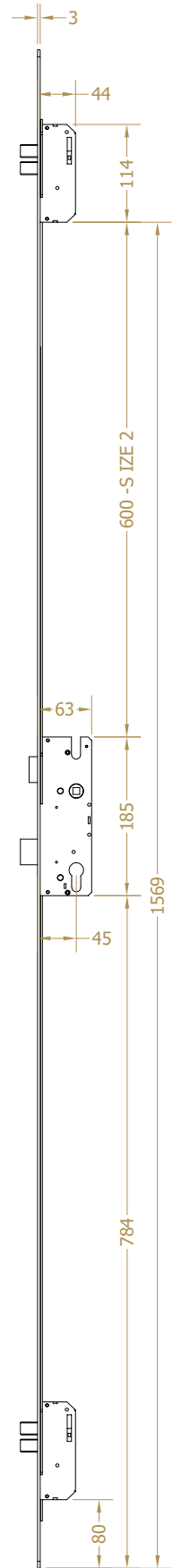
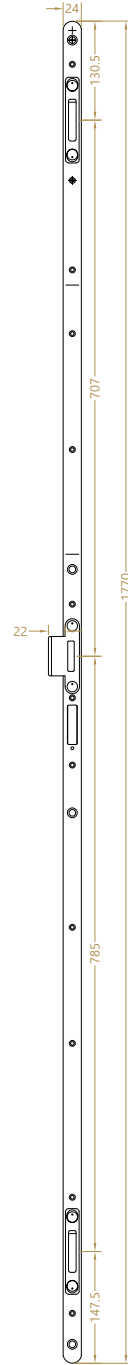

MK9-FTB-28S

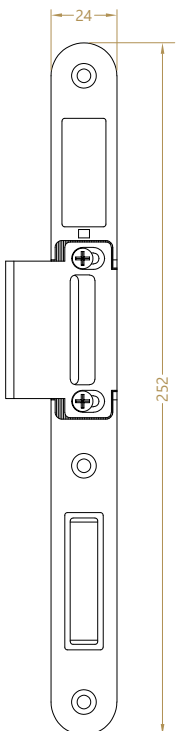

MK7-FLU

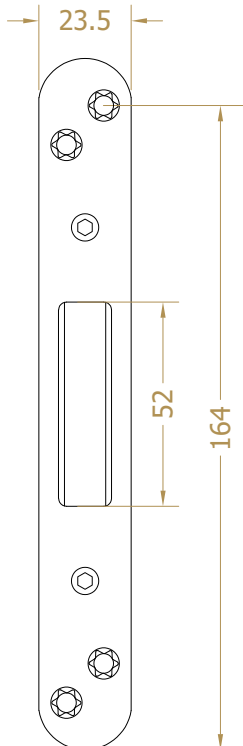

MK10

