

Drawing Revision History		
Revision	Description/Change	Date
A	Release	3/2/2022

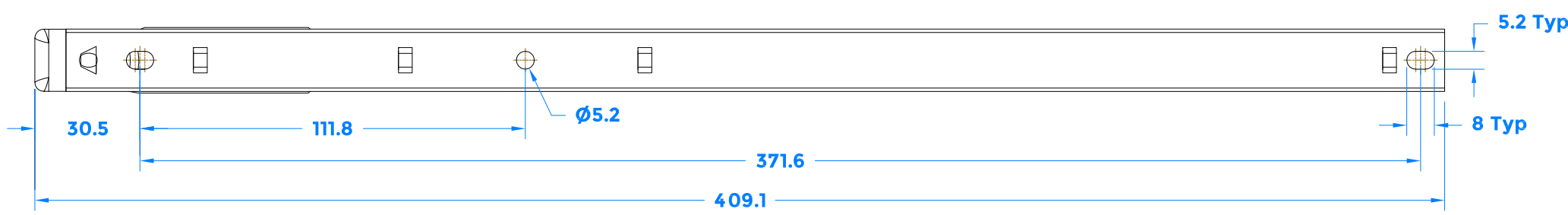
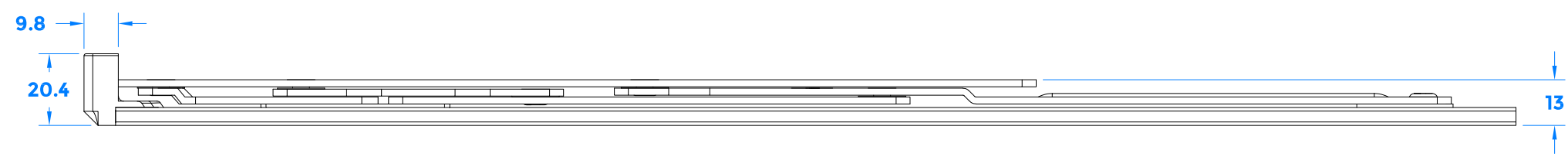
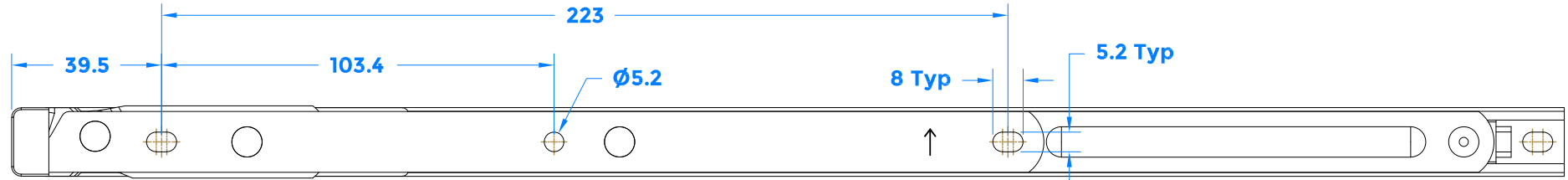
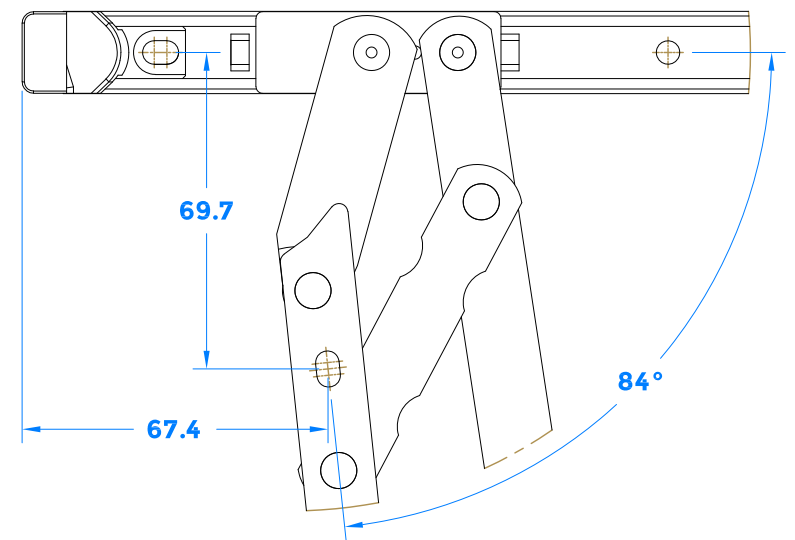
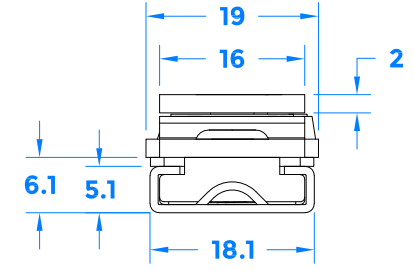
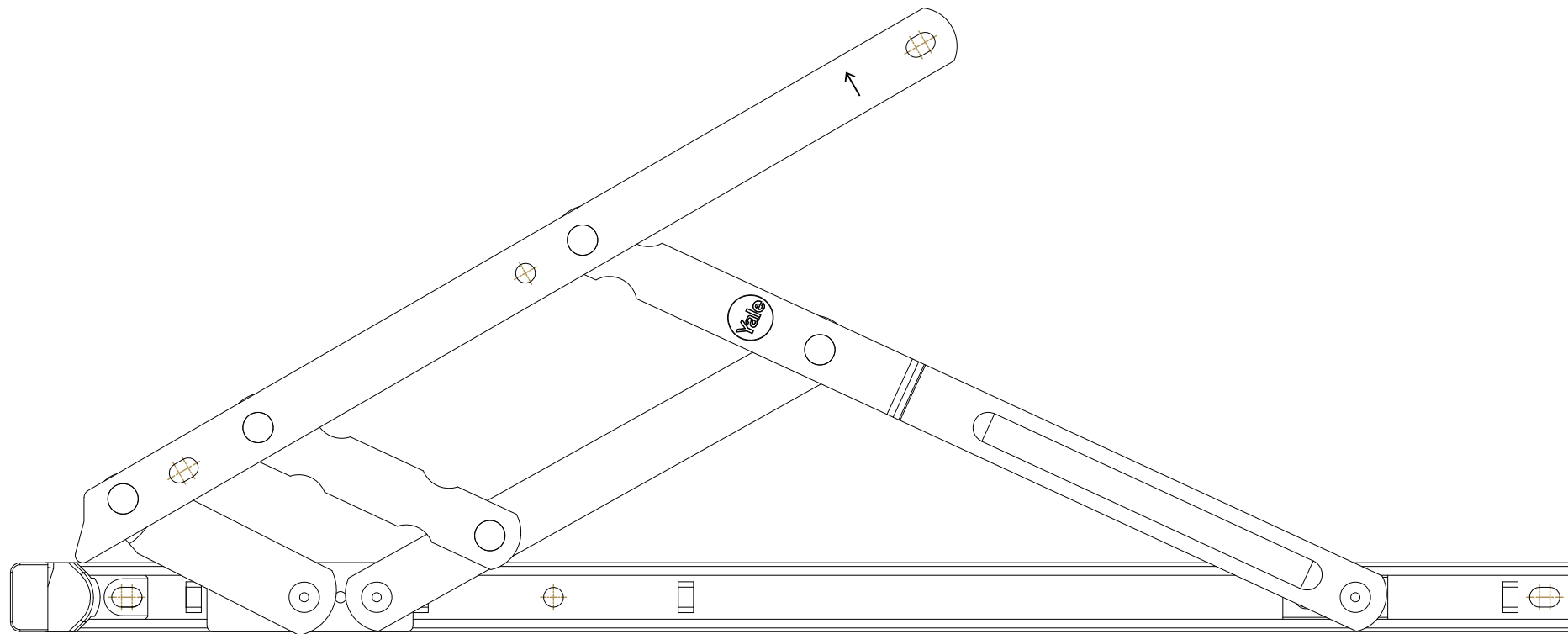

coastal-group.com
Shaping the future.

COASTAL

Part Number / Drawing Title:
DSEO16-PC-FSS
16" Egress Only Friction Hinge

Product Range:
Friction Hinges

Material: Ferritic Stainless Steel

Additional Info: Side Hung Hinge

Date Drawn: 03/02/2022

Drawn By: Phillip Walklett

Part Number: DSEO16-PC-FSS

File Name: DSEO16-PC-FSS.dwg

Revision: A

Drawing Scale: Not to Scale

Sheet Number: 1 of 1

THIRD ANGLE PROJECTION

This drawing and specification are the property of Coastal Specialist Ironmongery Ltd, they are issued in strict confidence and shall not be reproduced, copied or used without written permission.
EAOE - All dimensions are specified in mm.