

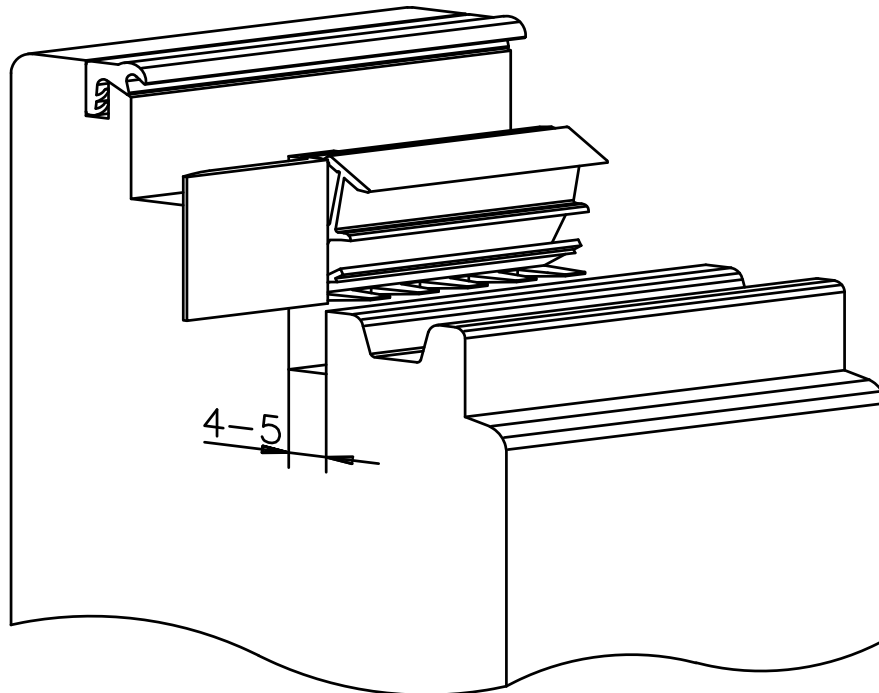

REVISIONS			
Revision	Description	Drawn	Date
A	Release	PW	15/2/18

SP-VESU19
For a 12mm Rebate

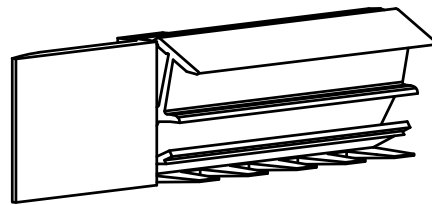
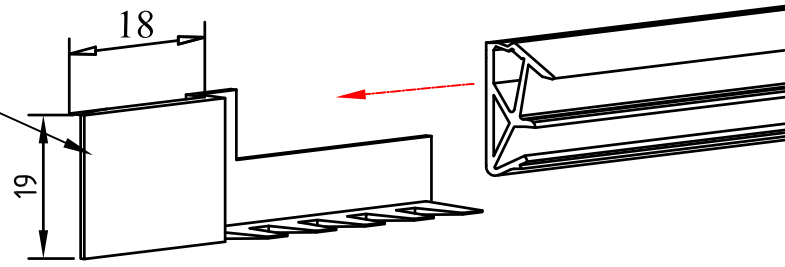
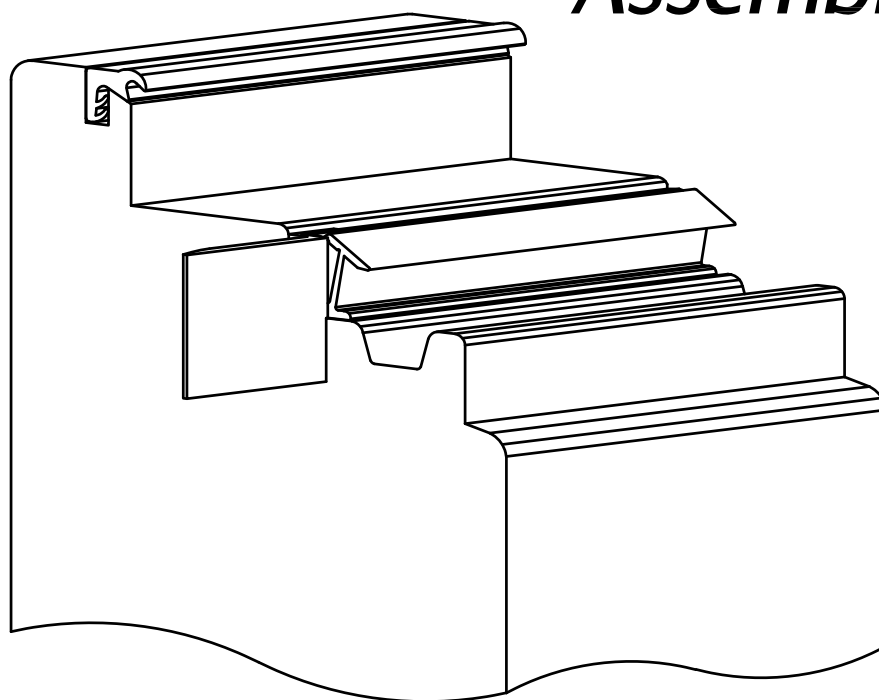

Assembled View



	
Global House, Bojea Industrial Estate, Trethowel, St Austell, PL25 5RJ Telephone 01726 871725 - Fax 01726 871731 Email sales@coastal-group.com - Web www.coastal-group.com	
Drawing Reference:	
Coastal Group	
Drawing Title:	
SP-VESU19	
Double Doors with 12mm Rebate	
Product Range:	
Weatherseals	
Additional Info: Supplied as a pair.	
Date Drawn:	15/02/2018
Drawn By:	Phil Walklett
Part Number:	SP-VESU19
File Name:	CG-SP-VESU19.dwg
Revision:	A
Drawing Scale:	1:1 @ A3
Sheet Number:	1 of 1
THIRD ANGLE PROJECTION 	This drawing and specification are the property of Coastal Group, they are issued in strict confidence and shall not be reproduced, copied or used without written permission.